

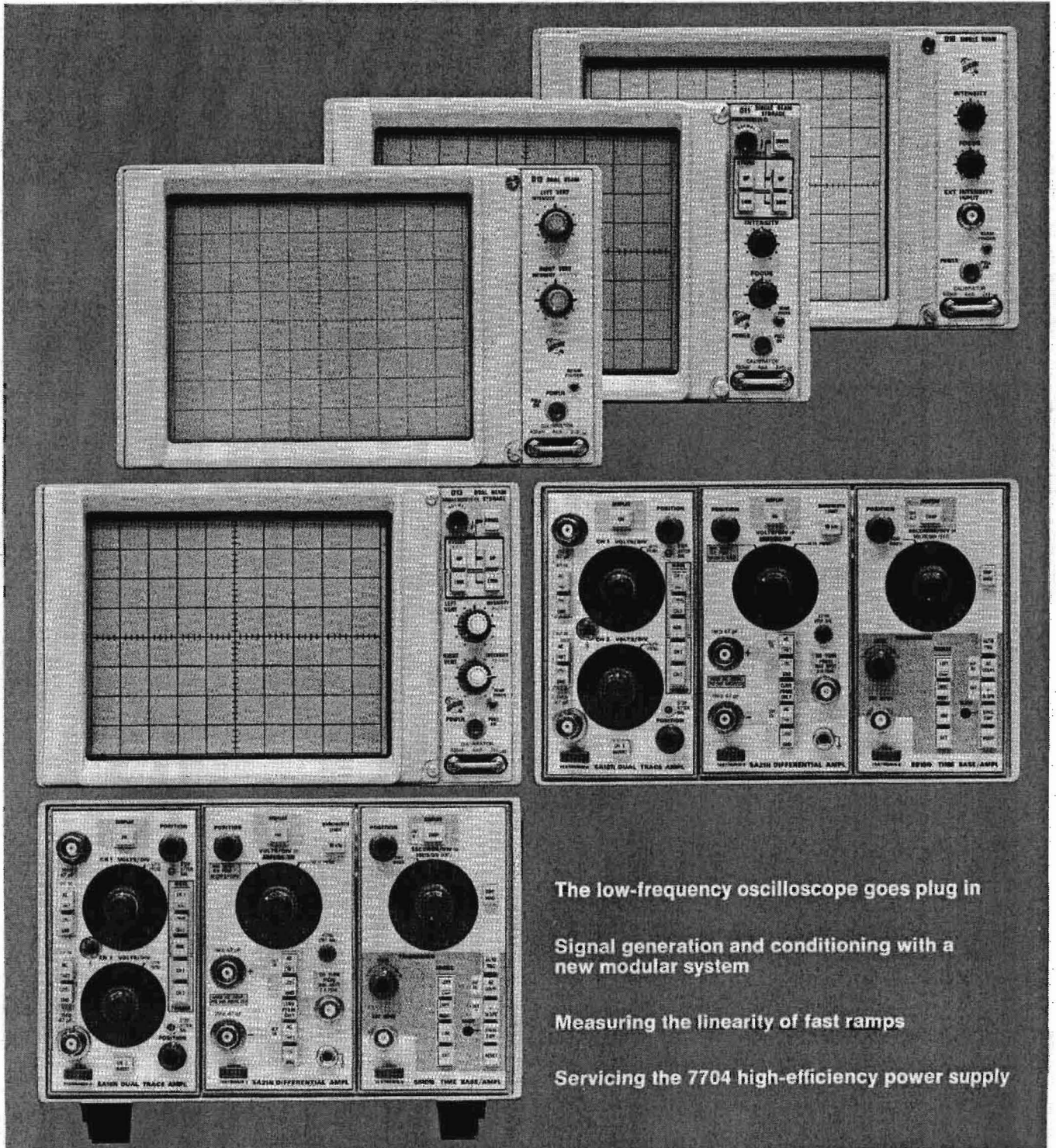

TEKSCOPE

MARCH 1971



The low-frequency oscilloscope goes plug in

Signal generation and conditioning with a new modular system

Measuring the linearity of fast ramps

Servicing the 7704 high-efficiency power supply

THE LOW-FREQUENCY OSCILLOSCOPE GOES PLUG-IN

Gary Vance, Project Engineer and George Hull, Design Engineer on the 5100 Series discuss sweep-switching operation of the 5B12N Dual Time Base Plug-In.

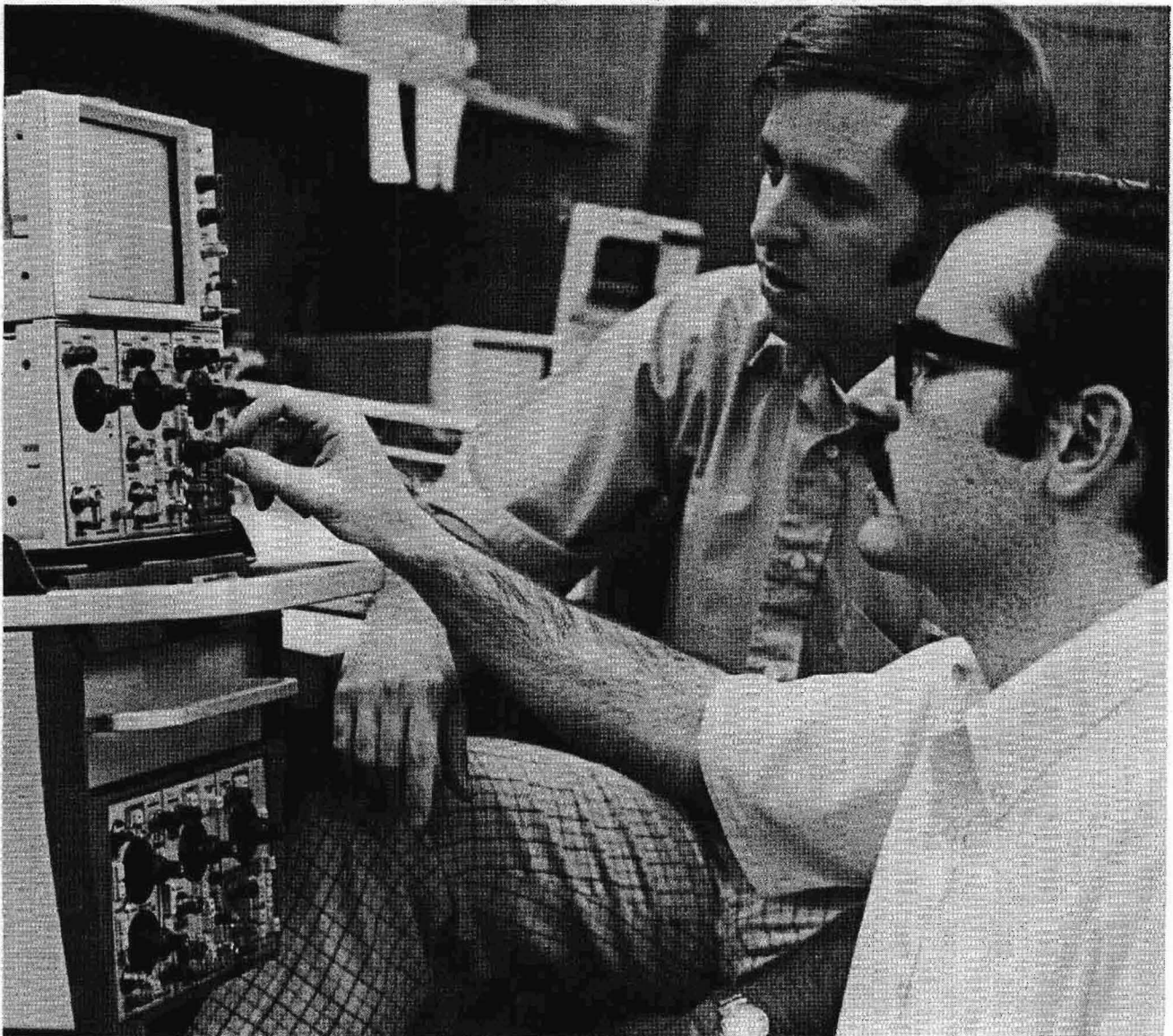

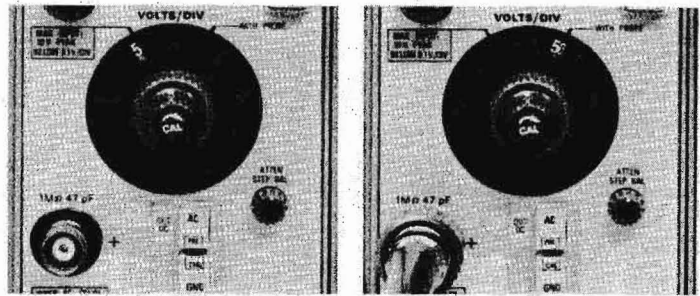

Scale factor readout changes automatically to indicate vertical sensitivity at probe tip when recommended 10X probe is used. Similarly, sweep-rate readout changes automatically when 10X magnifier is turned on.

By Jerry Shannon and Ahne Oosterhof

In the oscilloscope field, plug-in versatility has traditionally been limited to high-frequency instruments. Introduced by Tektronix in 1954, the plug-in concept allowed the user to easily and inexpensively change the characteristics of his oscilloscope to cover a wide range of applications.

Now, with the introduction of the 5100 Series, the users of low-frequency oscilloscopes will enjoy these same benefits.

Since the same need for versatility exists in the low-frequency as in the high-frequency oscilloscope field, we determined to do our best to meet that need. Our goal was to offer a laboratory-quality, low-frequency, plug-in oscilloscope at the lowest practical cost to the user. We also wanted to include many of the features such as scale factor readout, large screen CRT and solid state stability found only in the latest instruments.

Breakthroughs would have to be made in many areas. Simplified circuit design, new production techniques for CRT's, switches and other components, and reduced assembly and calibration time would have to be achieved if we were to reach our goal. The end result of our efforts in all of these areas is a series of products that bring you new measurement capability, plus a flexibility previously unavailable in any other oscilloscope system.

First in this series is the 5103N Oscilloscope System, a general-purpose, low-frequency (DC to 2 MHz) oscilloscope featuring cost-saving innovations such as interchangeable display modules, plug-ins, and bench to rackmount convertibility. Four display modules, each with a large 6½-inch CRT, give you a choice of single beam, dual beam, single beam storage or dual beam storage. You can readily change from one display module to another or convert from bench to 5¼-inch rackmount configuration in a matter of minutes. Nine plug-ins give you a wide choice of vertical amplifiers and time bases.

Several innovations in the amplifier and time base plug-ins enhance operating ease. For example, scale factor readout for each amplifier is provided by illuminating the knob skirt behind the area identifying the correct scale factor, even when using the recommended 10X probes. This same feature is used in the time base plug-ins to indicate correct sweep rate with the magnifier on or off. The possibility of measurement error is thus greatly reduced.

The choice between left and right vertical plug-in is made by depressing the DISPLAY button on the respective plug-in. This button also switches the light on behind the readout skirt, so a glance is all that's needed to immediately identify which channels or plug-ins are in use. With neither DISPLAY button depressed, the left hand vertical is displayed but its readout is not illuminated.

When two amplifier plug-ins are enabled, the mainframe automatically converts to the alternate or chopped mode of operation as selected by the DISPLAY button on the time base. The switching sequence allots two time-slots (in chopped) or two sweeps (in alternate) to each vertical plug-in. When dual-channel plug-ins are used, each channel takes one time slot or one sweep. In the dual-beam mainframe, switching between plug-ins is eliminated as each amplifier is permanently connected to one vertical deflection system.

THE MAINFRAME

Now let's take a closer look at each of the 5100 Series modules. The 5103N mainframe module contains the low-voltage power supplies, horizontal and vertical amplifiers, the electronic switching and logic circuitry for dual-trace operation between plug-ins, and three plug-in compartments. It will interface directly with any of the four display modules in a bench or rackmount configuration. Any plug-in can be used in any compartment to achieve X-Y, Y-T or raster displays.

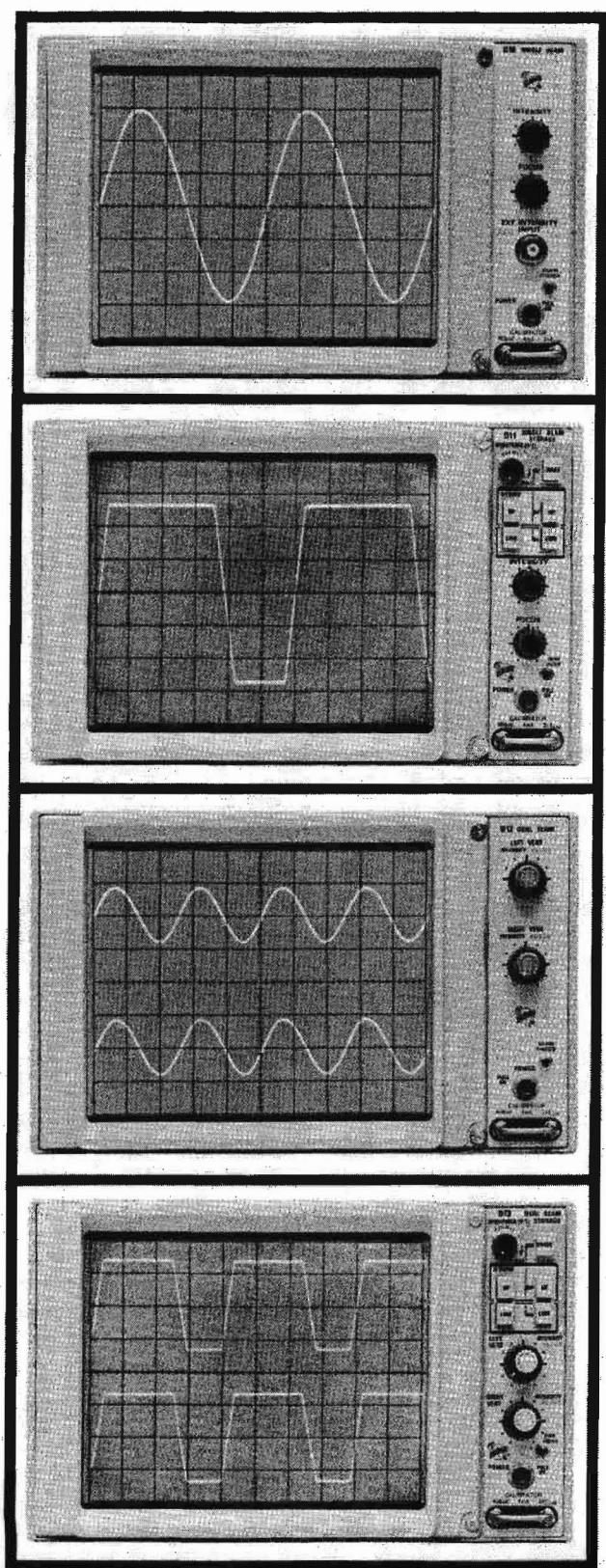

Four display modules pictured from top to bottom are single beam, single beam storage, dual beam and dual beam storage. All feature a large 6¼" screen and internal graticule.

THE DISPLAY MODULES

Each of the display modules uses a new 6½-inch ceramic CRT with an 8 x 10 division (½ inch/div) internal graticule. The CRT, with 3.5 kV accelerating potential, has a bright, well-defined trace. Simplest of the display modules is the D10 single-beam display unit. In addition to the CRT, it contains the high-voltage supply, a voltage, current and time (2X line frequency) calibrator, the CRT controls and the power switch. A beam finder positions the beam on screen regardless of the setting of the vertical or horizontal position controls. The front panel Z-axis input with DC to 1-MHz bandwidth requires only 5 volts to modulate the beam.

The D12 dual-beam display module is the same as the D10 single-beam unit except the CRT has two writing guns and two pairs of vertical deflection plates. Both beams cover the full 8 x 10 division screen. Also included are separate intensity and focus controls for each beam.

Single and dual-beam storage operation are provided by the D11 and D13 display modules respectively. The bistable, split-screen storage CRT's have a unique brightness control which permits varying the stored brightness to retain the image for several hours without damage to the CRT. The brightness control, in conjunction with other storage controls, also allows integration of repetitive signals to effectively increase stored writing rate.

THE PLUG-INS

The nine plug-ins presently available include six amplifiers and three time bases. Simplest of the amplifiers is a plug-in having just an input stage with a potentiometer as an attenuator. Designated the 5A24N, the unit has a 50 mV/div sensitivity and is ideal for you who have low-cost monitor needs.

For simple measurements where signals of varying amplitude have to be measured, the 5A23N with decade attenuator steps and a 10 mV sensitivity is available. Bandwidth is DC to 1 MHz.

A companion plug-in, the 5B13N time base, provides a low cost sweep unit with sweep ranges from 5 μs/div to 0.5 sec/div in decade steps. A variable control extends the slowest sweep to 5 sec/div.

When signals of only a few millivolts are to be measured, the 5A15N provides 1 mV sensitivity and DC to 2-MHz bandwidth. The 5A18N offers the same characteristics with dual-trace capability including the convenient ADD mode. This mode is especially useful when signal differences between two points are to be measured while both points are elevated by a common signal.

Getting down into the difficult microvolt region where the applications call for low noise and high common-mode rejection, the 5A20N and 5A21N differential amplifiers with FET inputs provide stable operation to 50 μ V/div. Bandwidth is DC to 1 MHz. Upper bandwidth can be limited to 10 kHz for noise reduction. Common-mode rejection at 50 μ V/div, DC coupled, is 100,000:1.

To permit common-mode measurements with the use of attenuator probes, a probe having accurate attenuation has been developed. The P6060 has 10X attenuation and provides common-mode rejection of 400:1 at any deflection factor when used with the 5A20N or 5A21N.

The 5A21N plug-in, while similar to the 5A20N, has the added feature of a current-probe input. Using the P6021 current probe, bandwidth is 15 Hz to 1 MHz with sensitivities from 0.5 mA/div to 0.5 A/div. The normal 100 Hz low-frequency response of the P6021 is extended by low-frequency correction in the amplifier to permit measurements at line frequency. This makes the unit especially useful in power supply design work.

Many low-frequency applications make use of X-Y type displays. As the mainframe has identical vertical and horizontal deflection systems it is possible to make accurate phase measurements using two identical plug-ins. A control on the deflection amplifier board allows phase calibration to better than one degree at specific frequencies up to 1 MHz.

Two more time bases round out the selection of plug-ins available. The 5B10N provides sweep ranges from

1 μ s/div to 5 sec/div in a 1-2-5 sequence with a 10X magnifier extending the fastest sweep to 100 ns/div. The unit offers versatile triggering from DC to 2 MHz. Both trigger source and trigger mode are selected by pushbutton. A single-sweep mode simplifies the capturing of single-shot phenomena for photographing or storing displays. Included is an external horizontal mode which provides a convenient means for making simple X-Y measurements. Sensitivity is 50 mV/div with DC to 1-MHz bandwidth.

A dual time base, the 5B12N, covers a wide range of applications. Offering the maximum in versatility, it includes the popular sweep switching introduced in the 547 Oscilloscope. In the dual-sweep mode, the A sweep is slaved to the left plug-in, and the B sweep is slaved to the right plug-in. This gives you, in effect, dual-beam operation for repetitive signals. The two sweeps can also be operated in the conventional delaying-sweep modes with a 10-turn delay multiplier providing accurate delay settings. The 5B12N also includes an external horizontal mode for X-Y operation.

Some applications require a vertical sweep or raster presentation. This is easily accomplished by plugging any of the three time bases into one of the vertical compartments. The 5103N provides convenient front panel access for Z-axis modulation in these applications.

A low-cost camera, the C-5, complements the low-frequency 5100-Series instruments. Its fixed-focus, fixed-aperture design makes waveform photography simple. An access door in the top of the camera allows viewing the CRT without removing the camera.

Some of the areas expected to benefit from the versatility of the 5100 Series are medical research, educational instruction, low-frequency phase work such as servos, mechanical analysis using strain gauges and other transducers, and engine analysis.

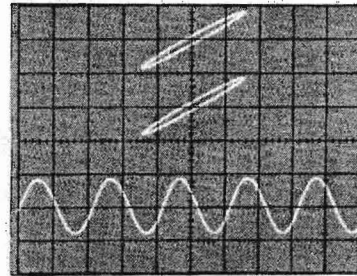
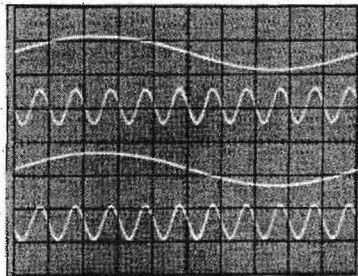
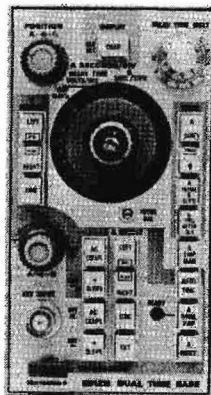

Dual-trace vertical and dual time base plug-ins offer maximum versatility. At left above, both Ch 1 and Ch 2 are displayed by both A and B sweeps. Right above, adding a single trace plug-in, with A sweep on EXTERNAL you can have dual-trace X-Y, while right vertical and B sweep provide Y-T.

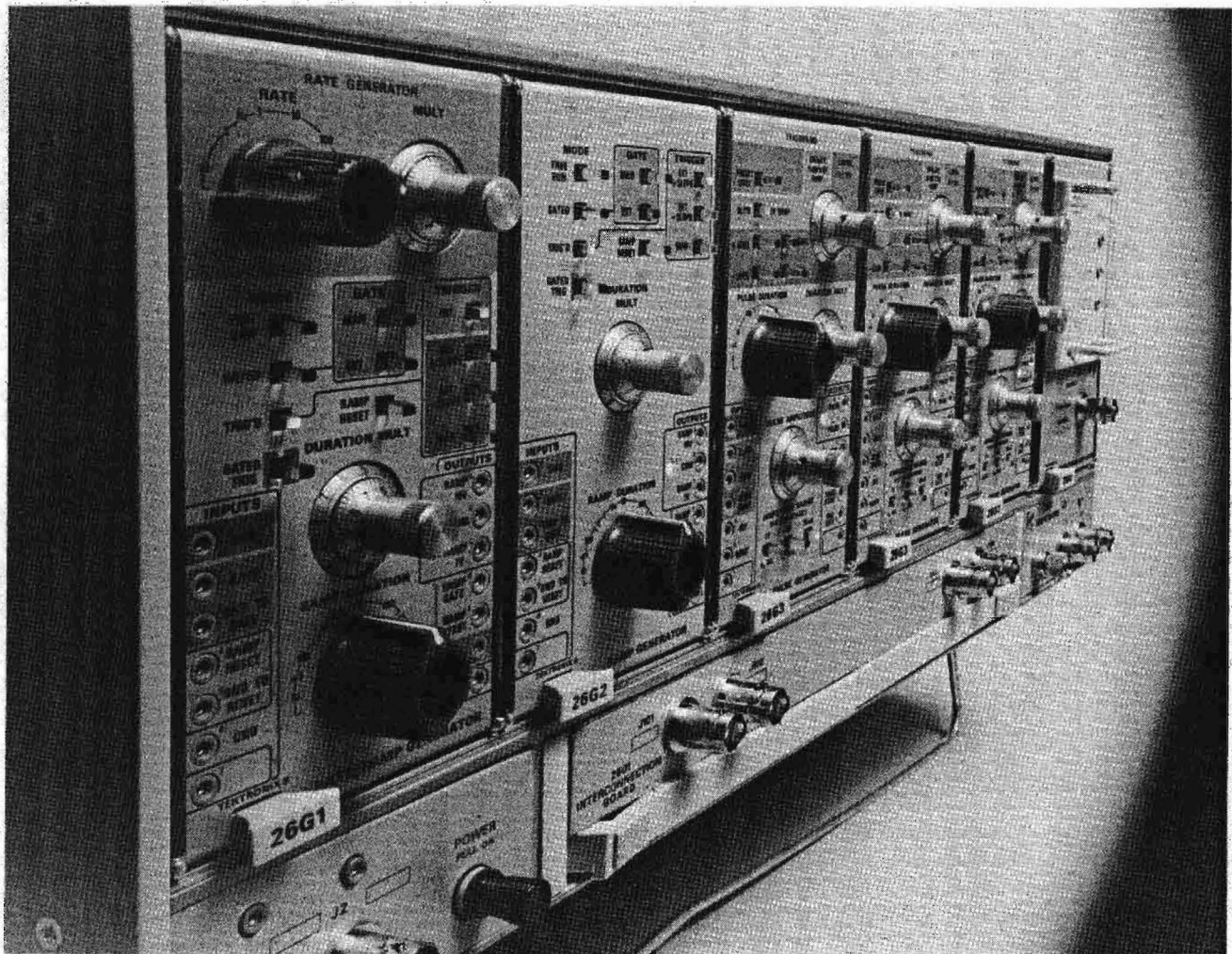

SIGNAL GENERATION & CONDITIONING

WITH A NEW MODULAR SYSTEM

Plug-in versatility has proven its worth in oscilloscopes, counters, pulse generators and myriad other products. Now this concept is extended to a new series of instruments designed to be the meeting place for many different systems. We call them the 2600-Series modular instruments. The term "modular" is used here in a broad sense and includes packaging, interconnections, input/output characteristics, power supplies and accessories.

Designed to permit relatively free interplay between analog and digital circuits, most inputs and outputs are compatible with DTL and TTL logic levels. However, they differ electrically slightly to allow proper operation with non-DTL and non-TTL circuits.

To get a feel for the versatility of the series, let's look briefly at the individual units.

2601 MAINFRAME

The 2601 mainframe, a basic element in the series, is a power supply and interconnecting system for 2600-Series plug-in units. Providing pre-regulated voltages at up to 50 watts, the 2601 accommodates six plug-in units. The pre-regulated voltages are further regulated in the individual plug-ins and, in some instances, used to power DC to DC converters for special needs. This provides maximum decoupling between units.

A seventh plug-in section in the 2601 plays a vital role in the versatility offered by the 2600 Series. It contains the interconnection board. The primary function of this board is controlling plug-in unit operation, processing signals to or from a plug-in, or passing signals between units. Thus, having planned and set up system operation from the front panel, you can duplicate the connections between units on the interconnection board and then tuck them away out of sight. Spare boards may be used to change rapidly from one setup to another. Most plug-in front panel inputs and outputs are coupled through the interface connections at the rear of the plug-ins and are duplicated on the interconnection board.

Pictured below are two of the interconnection boards currently available. The board on the left is used primarily to provide interconnection between plug-ins.

The board on the right also provides interconnection between plug-in units but has an exciting additional feature. Fourteen 16-pin dual in-line plastic I.C. sockets, plus a locally regulated +5 volt supply, are mounted on the board. Ready connection between I.C.'s and the plug-in units is made by standard 40-mil patch connectors. This permits you to add the relays, switches, pulse transformers, resistor networks, op amps and many other functions available in the dual in-line package, to the functions available in the 2600-Series plug-ins. Instrument versatility thus becomes virtually unlimited.

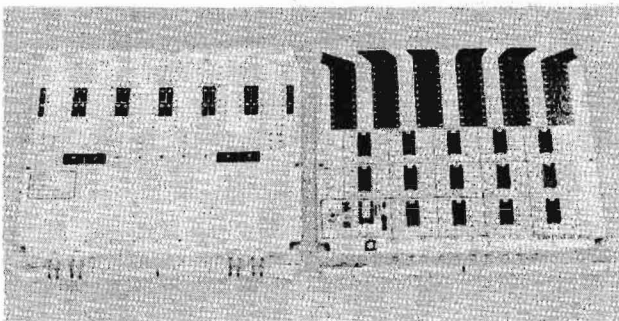

Interconnection board at left permits internal connection between plug-ins. Board at right interfaces plug-ins with 14 IC sockets. Board includes +5 V regulated supply to power IC's.

You may also elect to use the I.C. board and 2601 mainframe plug-ins completely independent of one another. Ten spare front panel jacks on the interconnection board provide convenient interface points. Front and rear panel BNC connectors on the 2601 may also be connected internally to any jack on the I.C. interconnection board. The pre-regulated +17 and -17 volt supplies are available on the board and can often be used to power linear I.C.'s where other than +5 volts is required.

RATE AND RAMP GENERATORS

Now let's take a look at the plug-ins. The 26G1 and 26G2 are basically ramp generators and produce ramp voltages ideal for analog timing applications such as delayed triggering of pulse generators, time bases for monitors, and raster generation.

Several ramp modes are available to you. Free run, gated, triggered, and gated trigger, plus manually gated or triggered operation is readily accomplished from the front panel. In addition, the 26G1 can be internally triggered by the rate generator which is an integral part of the unit. The trigger and gate levels, both input and output, are compatible with logic levels used in most DTL and TTL logic devices.

A convenient feature is the ability to terminate the ramp at any point in its excursion by applying a positive logic 1 to the Ramp Reset input or a logic 0 to the Ground to Reset input. This provides for some interesting possibilities. For example, the 26G1 or 26G2 can serve as a time-to-height converter. The amplitude of the ramp output can be made proportional to the input pulse width simply by feeding the pulse into both the Trig and Ground to Reset inputs. The ramp is then started by the leading edge of the pulse and terminated when the pulse falls to zero.

In addition to the main ramp output of 10 volts, several other signals are available at the front panel. A 1-volt ramp output serves as a convenient time base for the 601, 602 and 611 monitors which are ideal companion units to the 2600 Series. The +3-volt Ramp Gate, of the same duration as the ramp, provides unblanking for the monitor. A +3-volt, 1.5- μ s pulse coincident with the start of the ramp is handy to trigger your oscilloscope or other associated circuitry used in the application.

We mentioned earlier that the 26G1 also contains a rate generator. Normally free-running at a frequency determined by the Rate and Multiplier settings, it can also be gated manually or by an external gate. All that is needed is reversal of an internal 3-pin connector. The Gate and Ground to Gate inputs then serve to gate the rate generator, with the first pulse from the rate generator coincident with the start of the gate. The rate generator may be used independent of the ramp generator portion of the 26G1.

PULSE GENERATION

The 26G3 Pulse Generator plug-in unit provides precise rectangular pulses with amplitude to ± 10 volts and pulse duration from $1\mu\text{s}$ to 11 seconds. Pulse risetime and falltime is less than 200 ns. In addition, the unit has two other output modes. With the Pulse Duration control set to Bistable, the output changes state with each succeeding trigger; that is, the output goes to the high state on one trigger and to the low state on the next. A highly symmetrical waveform or pulses longer than 11 seconds can thus be easily generated.

The third mode, DC, or as it is sometimes called, "locked on", is appearing with increasing frequency on the newer pulse generators. In this mode the output is simply a DC level which can be accurately set to any value up to ± 10 volts by means of the Pulse Amplitude control. Accuracy is 1% of full scale, full scale being 1 volt, 10 volts, or a value you may choose by selecting an appropriate external resistance. Output current up to 20 mA is available to drive the selected resistance, however, maximum output voltage is limited to ± 10 volts.

Three other outputs are available on the front panel: the Pulse Start, a +3-volt pulse serving as an output trigger; the Pulse Gate, a +3-volt gate with the same duration as the pulse output; and the Trigger Gate, a +3-volt gate coincident with the start of the pulse output and whose width is determined by the Delay control setting.

Turning to the 26G3 inputs, we see a wide range of control for starting and stopping the pulse. Selection of slope and level, much the same as on your oscilloscope, is available. A preset +1-volt level is useful when triggering from logic circuits, and a ramp input provides for triggering at any point on a +10-volt ramp giving you a choice of accurate time delay before starting the pulse. The Slew Ramp input offers some interesting capabilities; a signal fed into this input is combined algebraically with the signal fed into the Ramp input to effect triggering. This gives you a convenient means of generating two pulses whose time relationship can be made to change at a controlled, linear rate.

One of the common uses of this technique is found in the field of biophysical research, the objective being to determine the ability of a nerve to respond to separate stimuli occurring within a brief time span. A look at how we can accomplish this objective using the 2600 Series will serve to demonstrate the flexibility of the system, but first let's finish our review of the 26G3 inputs.

In addition to the Trigger, Ramp and Slew Ramp inputs, there are Set and Reset inputs. A +1-volt signal to the Set input, will set the output to its high state regardless of the state of all other inputs except the Reset input. Conversely, a +1-volt signal to the Reset input will set the output to its low state regardless of the state of all other inputs including the Set input.

SYSTEM APPLICATION

Now let's look at how we can accomplish the objective mentioned above, that of determining nerve response to closely spaced stimuli, using the 2600-Series instruments. The block diagram below shows the system we can use to generate the variable-spaced pulses, including a 601 monitor to display the pulses. The system consists of the 2601 Mainframe, the 26G1 Rate/Ramp Generator, the 26G2 Ramp Generator, the 26G3 Pulse Generator and the 601 Storage Display Unit.

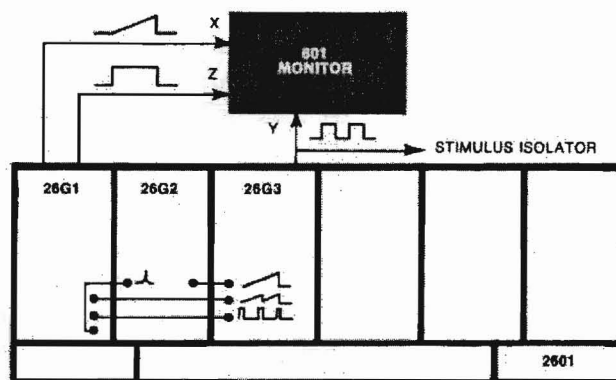

Simplified block diagram of system to produce pulse pairs having gradually reduced spacing between pulses.

Interconnection of the units and the control settings for the respective units are shown on the interconnection board worksheet at right. These worksheets are replicas of the interconnection board and provide a handy reference for repeating the set-up for a particular measurement. Replicas of the front panels of the plug-in units are available with gummed backing for pasting on the worksheet as shown. The photo in the lower right-hand corner of the worksheet shows the signal generated by the set-up.

The pulse train is initiated by pressing the Manual button on the 26G2. The 26G2 performs four functions. It starts the pulse train, gates the 26G1, provides the slew ramp for the 26G3 and determines the total period over which the nerve will be exercised, in this instance, 10 seconds.

The 26G1 also performs four functions. It determines how often the 26G3 generates pulse pairs, provides the ramp input for the 26G3, determines, in conjunction with the slew ramp and the Delay control setting on the 26G3, when a stimulus pulse will be generated, and provides the sweep and unblanking signals for the 601 monitor.

The 26G3 merely stands by and generates a pulse of the appropriate duration and amplitude when its triggering level is reached.

Now let's see what happens when we push the Manual button on the 26G2. A single pulse, 1 volt in amplitude and 300 μ s in duration is generated, followed by an identical pulse 10 ms later. The two pulses are then repeated at 1.5 sec intervals with the time between them reduced 1.5 ms each time they repeat. A reset pulse from the 26G1 prevents the slew ramp from triggering the 26G3 at the peak of its excursion, producing an unwanted pulse.

OUTPUT CONDITIONING

One other important plug-in currently available in the 2600 Series is the 26A1 Operational Amplifier. It is a high-power operational amplifier ideal for final processing of signals generated in 2600-Series system. Output capabilities are ± 50 V and up to ± 50 mA. Open loop gain is 10,000 into a 1 k Ω load with a unity gain bandwidth of 5 MHz.

Access to the operational amplifier inputs and outputs is via a Terminal Access Adapter which plugs into the plug-in unit. The adapter also provides access to the front panel connectors and the regulated +15 and -15 volt supplies. Clips and jacks are mounted on the adapter circuit board so you can easily change the operational amplifier function. A Terminal Access Adapter kit which includes a circuit board with a 0.1 x 0.1 inch grid of plated-through holes is available for constructing circuits to meet your specific needs.

7000-SERIES COMPATIBILITY

The 2600 Series also brings new capabilities to you who own 7000-Series oscilloscopes. Through the use of an adapter, you can operate any of the 2600-Series plug-ins in your 7000-Series mainframe; truly plug-in versatility at its best.

TEKTRONIX FORM NUMBER
062-1265-00
(Pad of 50 sheets)

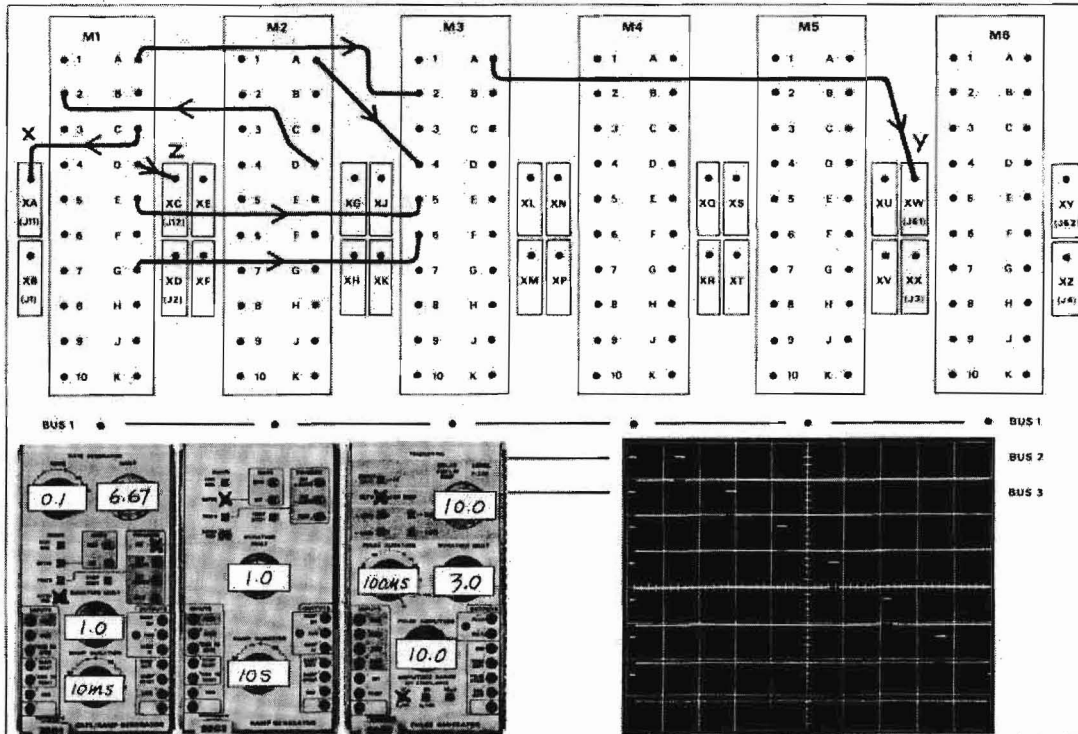

NOTES: A 10-second train of paired pulses, each pulse 300 μ s in duration, 1.0 volt in amplitude. Pulse pairs repeated at 1.5 second intervals with the time between pulses reduced 1.5 ms each repetition. Pin 15 of U70 in the 26G1 is connected to output G on the 26G1 for a reset pulse. A 601 Storage Display Unit serves as monitor.

SYSTEM FUNCTION: Staved Pulses for Nerve Stimulation
USER: D. Clark
DATE: 2-1-71

INTERCONNECTION BOARD 670-0397-00



Interconnection board worksheet shows connections between units, front panel control settings and waveforms generated by set-up. Notes include signal parameters and special instructions. Worksheet provides permanent record of set-up.

TEKNIQUE: measuring the linearity of fast ramps

By John McCormick, Project Engineer

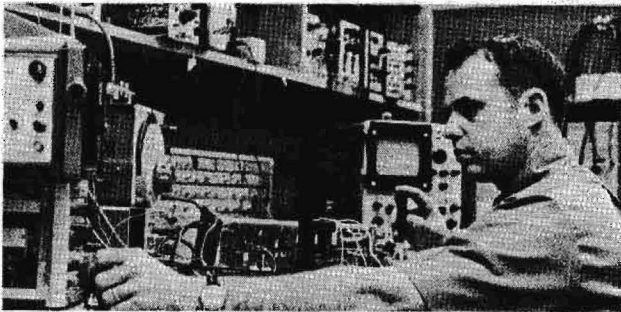

John received his BSEE, with distinction, from U of Kansas in 1962 and his MSE with a Materials Sciences Option from Princeton in 1965. With Tek since 1965, he has contributed much to fast-ramp technology while working on sampling sweeps.

The time measurements you make with your oscilloscope can only be as accurate as the time base displayed on the CRT screen. Improvements in components, ramp generator circuitry and CRT construction have given us time bases specified accurate within 2 or 3% and typically accurate within 1%. With the great strides being made in vertical amplifier bandwidth has come the challenge of providing the fast sweeps needed to properly display these higher-speed phenomena. Generating and measuring fast, linear ramps poses unique problems. This article discusses a solution for one of those problems, that of measuring the linearity of fast ramps.

There are two important quantities used to specify and describe a ramp. These are the mean slope of the ramp, and linearity or slope deviation from the mean. An ideal ramp has a constant slope and is perfectly linear. It is usually easy to measure the mean slope of the ramp but linearity measurements are difficult to make and are usually made in an indirect manner. This is especially true in the case of very fast ramps (tens of nanoseconds in length).

The terminology used to describe linearity varies according to the method used to measure it. A sampling oscilloscope can form the basis for a convenient and precise method of ramp slope and linearity measurements. However, before describing the method it will be necessary to define a few terms.

DEFINITIONS

Mathematically speaking, the slope of a waveform at any point in time is the derivative of the waveform with respect to time. If $V(t)$ is a voltage waveform, then the slope at any time is given by

$$\text{slope} = m(t) = \frac{dV(t)}{dt}$$

In the case of an ideal ramp, the slope would be constant. To describe a ramp we may consider an ideal ramp with the desired constant slope which we will call the mean slope, plus some deviations of the slope from this constant value.

$$m(t) = m_0 + I(t)$$

Where $m(t)$ is the actual slope at any given time, m_0 is the mean slope and $I(t)$ is the nonlinearity of the ramp.

Percentage of nonlinearity is expressed by the equation

$$\% \text{ Nonlinearity} = \left(\frac{m(t) - m_0}{m_0} \right) \times 100\% = \frac{I(t)}{m_0} \times 100\%$$

The nonlinearity is a function of time and can be determined if we know $m(t)$ and m_0 . It is relatively easy to measure m_0 by feeding the ramp into the vertical system of a scope and measuring its amplitude and duration: $m(t)$ is the time derivative of the ramp waveform. It is possible to measure an approximation to $m(t)$ by several methods, only one of which we will discuss in detail here.

The derivative of a voltage that is a function of time $V(t)$ is given by the basic definition:

$$\frac{dV(t)}{dt} = m(t) = \frac{V(t+\Delta t) - V(t)}{\Delta t}$$

limit $\Delta t \rightarrow 0$

What we can measure is

$$m^*(t) = \frac{V(t+\Delta t) - V(t)}{\Delta t}$$

Δt finite

It is obvious that $m^*(t)$ is just the average slope of the function $V(t)$ measured over a time Δt at each point in time as in Fig. 1. A convenient name for Δt is the time resolution or simply, the "resolution" of the measurement. The resolution is indicative of the detail that can be resolved. If the slope $m(t)$ has components which last for a time on the order of Δt as in Fig. 1, they will be smoothed out in the measurement. If the ramp has a fast start like the ideal ramp in Fig. 2(a), then the $m^*(t)$ Fig. 2(c) will differ from the actual derivative in Fig. 2(b) because of the finite resolution time. The smaller the resolution time, the closer $m^*(t)$ will be to $m(t)$. Now let's consider methods of measuring $m^*(t)$.

MEASUREMENT OF $m^*(t)$

One simple way to obtain $m^*(t)$ for a waveform would be to process the waveform with an analog differentiator as in Fig. 3. This works pretty well with slow ramps but is very difficult to implement for fast ramps. A better method for fast ramps makes use of sampling techniques to time-convert the ramp to a slower-speed replica. Measuring the slope is then an easy matter. The technique shown in Fig. 4 can be used to measure $V(t+\Delta t)$ and $V(t)$. The ramp waveform is fed into two identical sampling heads, A & B, each of which produces a DC voltage in its respective memory, proportional to the value of the ramp voltage at a time t_s when the strobe opens

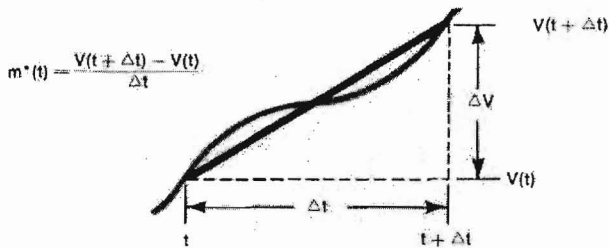

Fig. 1. Resolution limits measurement detail. Components lasting for a time on the order of Δt will be smoothed out.

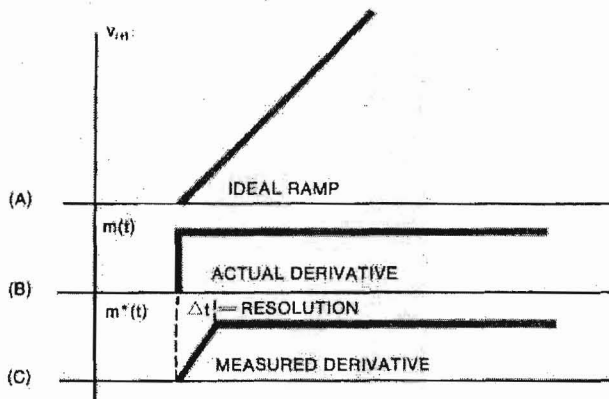

Fig. 2. Measured slope differs from the actual derivative because of the finite resolution time.

the sampling gate. If the strobe time for channel A (t_{SA}) is made different from that for channel B (t_{SB}) by some time (Δt) due to unequal delays T_A and T_B , then the voltage measured by the respective sampling heads will be

$$V_{SA} = V(t_{SA}) \quad V_{SB} = V(t_{SA} + \Delta t)$$

We can then subtract them at each time t .

$$V(t)_{B-A} = V_{SB} - V_{SA} = (V(t + \Delta t) - V(t))$$

If we divide the difference in strobe time Δt we have

$$\frac{V(t)_{B-A}}{\Delta t} = \frac{(V(t + \Delta t) - V(t))}{\Delta t} = m^*(t)$$

A convenient realization of the above technique can be obtained with a sampling system set up as in Fig. 5. The system consists of a 7000-Series four-compartment mainframe, a 7T11, two 7S1's, two S-1 sampling heads and a 7A22. If the signal cannot be loaded by 50Ω then a probe such as the P6034, P6035 or P6051 can be used to couple the signal to the power divider tee. An alternate approach would be to use S-3A or S-5 sampling heads in place of the S-1.

The gains of both sampling channels should be adjusted so that they are equal (note variable front panel control on the 7S11 does not effect the gain of the vert sig out). This can be done by inserting a variable attenuator in the leads from the vert sig out to the 7A22. Comparing the amplitudes of the two vertical signals out is easily done with the 7A22. Just feed both signals differentially into the 7A22 and adjust the gains until the base line is at the same level before and after the ramp.

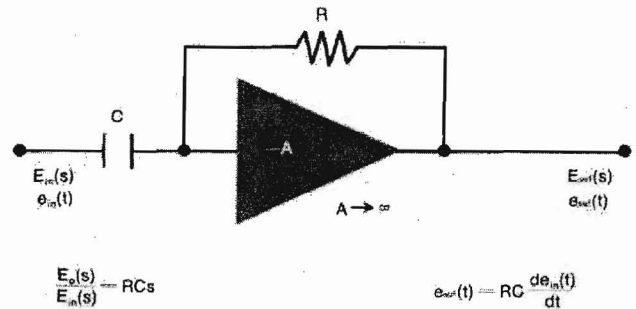

Fig. 3. Analog differentiator is a convenient means of measuring slope and linearity of slower ramps.

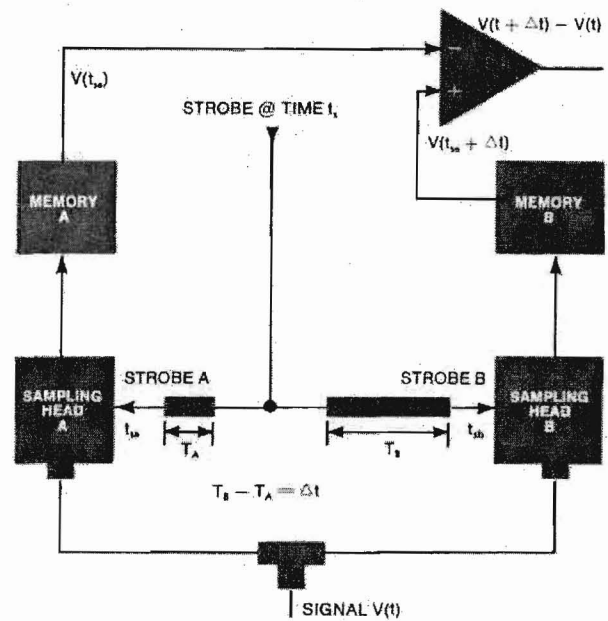

Fig. 4. Block diagram of a sampling system to measure $V(t + \Delta t) - V(t)$. Resolution is set by difference in time of T_A and T_B .

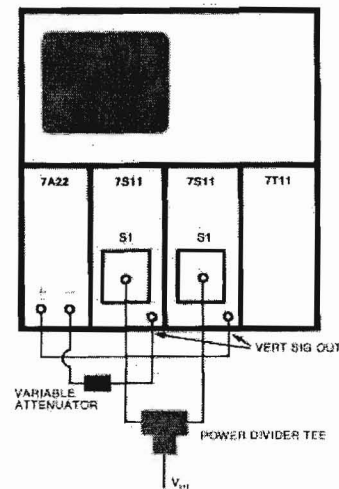
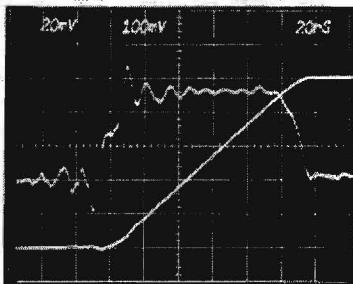
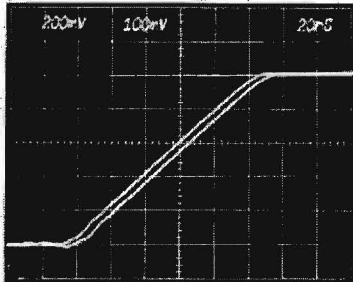

Fig. 5. 7000-Series system to measure ramp (Vt) and slope ($m^*(t)$) and display them simultaneously. Attenuator is placed in series with 7A22 input having largest signal so inputs to 7A22 may be set to same amplitude.

The resolution should be set by turning the right hand 7S11 Delay Control full CCW, grounding the negative input of the 7A22 and setting the left hand 7S11 Delay Control for the desired Δt by observing the separation of the two traces on the screen. Be sure to adjust the gain of the 7A22 using the variable if necessary so that the two traces have the same amplitude on the screen. The top photo below is a typical display for setting resolution.



Top photo is typical display for setting resolution. Bottom photo shows ramp and its slope. Aberrations are caused by nonlinearities in the ramp. Resolution is 6 ns.

After setting the desired resolution or Δt , the negative input of the 7A22 is moved to the DC position. Now displayed on the CRT is the voltage differential between the outputs of the samplers which is proportional to Δt and the slope of the ramp. Measuring the amplitude of this voltage differential and knowing Δt we arrive at $m^*(t)$ or the slope of the ramp.

The bottom photo above shows the slope waveform and the ramp whose slope it represents. Aberrations on the slope waveform are due to nonlinearities in the ramp. The amplitude of these aberrations relative to the amplitude of the slope waveform is the measure of the nonlinearities that exist in the ramp.

ACCURACY OF THE MEASUREMENT

Although the absolute slope in volts per nanosecond can be measured with this system, the accuracy is not as good as it is when measuring linearity unless the system is calibrated with a known slope. Contributing to the accuracy of the slope measurement are the accuracy of the sampling channel gains, the accuracy of the 7A22 gain, and the accuracy with which the time Δt is known.

One method of eliminating the problem of absolute sweep calibration for accurate Δt is to adjust for both channels to

sample at the same time and add a known length of delay line in the signal path of one of the sampling channels.

Two other factors effect the accuracy of the linearity measurements. These are nonlinearity in the vertical response and nonlinearity in the sampling sweep. Of the two, the sweep nonlinearity is the dominate effect. The linearity of the sweep is specified to be within 3% over most of the Time Position Range and can be checked by the usual method with accurate time marks. For sweep speeds with low magnification the linearity is typically better than 1%.

PRECISION OF THE MEASUREMENT

Precision refers to the ability to measure small differences in signal amplitude and is limited primarily by noise. With the system described we can easily measure 1% differences in slope. It must be borne in mind that the response of the 7S11's must be identical. A convenient way to assure this is to set the dot response of both 7S11's to unity. It is also important that the scan rate be slow enough for the bandpass used on the 7A22.

RANGE OF SLOPE MEASUREMENTS

The upper limit on slope, $m^*(t)$, in volts/nanosecond is determined by the risetime of the sampling system and our ability to set the resolution to be a small portion of the ramp. Ten to twenty percent of ramp duration yields good results. The system described provides resolution from 10 ns to less than 100 ps. We should keep in mind that as the resolution time decreases, so does the signal out and noise will be a problem. The 7A22 variable bandpass may be used to reduce noise but the display rate must decrease proportionally. This is easily done by varying the scan control on the 7T11.

The lower limit on $m^*(t)$ in volts/nanosecond is set by noise as the resolution time cannot be adjusted greater than 10 ns without instrument modification. A useful lower limit set by noise places the longest ramp length that can be measured with this system at about 500 ns. However, an external delay line can easily be inserted in the signal path of one sampling channel to extend the lower limit.

CONCLUSION

We have discussed how differentiation of a fast ramp leads to a convenient method of measuring ramp linearity and have shown how to construct such a measurement system. A ramp and its slope, $m^*(t)$, are shown in the bottom photo at left. The resolution is about 5% of the ramp length. The risetime of the slope can be measured as well as amplitude, overshoot, ringing and droop, just as if measuring a step response, and these quantities all relate to how linear the ramp is at any point. The advantage of having the ramp and the slope displayed simultaneously is that the effect of circuit adjustments affecting the slope are seen immediately.

The ability to differentiate fast waveforms can be useful in other applications as well, such as measuring impulse response by differentiating the step response. Differentiation of theoretical expressions has always been a useful technique in certain analysis (such as linearity of ramps), but with the ability to measure the derivative directly and display it, although limited by resolution time, the technique becomes even more useful.

SERVICE SCOPE

SERVICING THE 7704 HIGH-EFFICIENCY POWER SUPPLY

By Charles Phillips

Product Service Technician, Factory Service Center

This is the first in a series of articles on servicing the 7000-Series oscilloscopes. The 7704 serves as the basis for these articles since it contains most of the new circuitry, components and construction techniques we will be discussing. It is not our intent to discuss the general techniques used in troubleshooting oscilloscope circuitry as these were covered extensively in the February 1969 to February 1970 issues of *TEKSCOPE*. Copies of these articles are available through your field engineer.

Proper operation of the regulated low-voltage supplies is essential for the rest of the scope circuitry to function properly, so let's look at this section first.

The high-efficiency power supply used in the 7704 is a new concept in power supply design that results in appreciable savings in volume, weight and power consumption. It is called "high efficiency" because its efficiency is about 70% as compared to 45% for conventional supplies. The line-to-DC converter/regulator contains most of the unconventional circuitry so our discussion will deal primarily with this portion.

First, let's briefly review the theory of operation. The high-efficiency power supply is essentially a DC-to-DC converter. The line voltage is rectified, filtered and used to power an inverter which runs at approximately 25 kHz. The frequency at which the inverter runs is determined basically by the resonant frequency of a series-LC network placed in series with the primary of the power transformer. The inverter drives the primary of the power transformer supplying the desired secondary voltages. These are then rectified, filtered and regulated for circuit use.

Pre-regulation of the voltage applied to the power transformer is accomplished by controlling the frequency at which

the inverter runs. A sample of the secondary voltage is rectified and used to control the frequency of a monostable multivibrator. This multivibrator, in turn, controls the time that either half of the inverter can be triggered, thus controlling the inverter frequency. Circuit parameters are such that the multivibrator, and hence the inverter, always runs below the resonant frequency of the LC network. Remembering that the resonant LC network is in series with the primary of the power transformer, we can see that as the inverter frequency changes, the impedance of the LC network changes. The resultant change in voltage dropped across the LC network keeps the voltage applied to the primary constant. Pre-regulation to about 1% is achieved by this means.

Now, let's turn our attention to troubleshooting the supply. Assume you have made the usual preliminary checks; you have power to the instrument, the line selector on the rear of the instrument is in the correct position for the applied line voltage and the line voltage is within specified limits. The plug-ins have been removed to eliminate the possibility of their causing the power supply to malfunction.

With the instrument power off, check the two fuses located in the line selector cover on the rear of the instrument. If the line fuse, F800, is open the problem is probably in the line input circuitry. If the inverter fuse, F810, is open the inverter circuitry is probably faulty. In either case it will be necessary to remove the supply from the mainframe to make further checks. This is easily done by removing the four screws on the rear panel that secure the power unit, then sliding the unit out the rear of the instrument.

Before removing the power-unit cover, check to see that the neon bulb on the left side of the power unit has stopped flashing. The primary storage capacitors C813 and C814

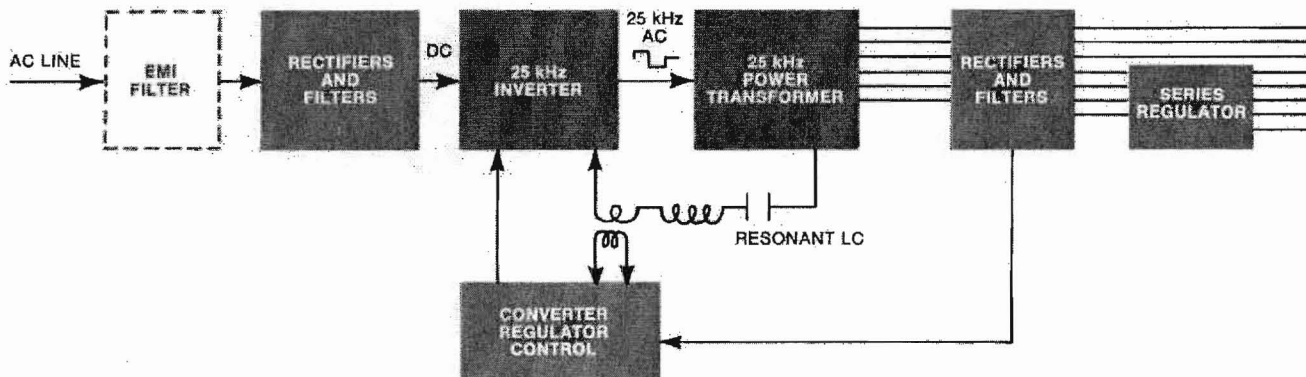

Simplified block diagram of high-efficiency low-voltage power supply.

remain charged with high voltage DC for several minutes after the power line is disconnected. When this voltage exceeds about 80 volts the neon bulb flashes. While servicing the power unit, the discharge time of the storage capacitors can be speeded up by temporarily disabling the inverter stop circuit. Pulling Q864 before turning off the scope power will allow the inverter to keep running for a short time, thus draining most of the charge from the capacitors. A voltmeter reading between test points 810 and 811 on the line input board will indicate the charge remaining on the storage capacitors. Allow at least one minute for the current-limiting thermistors to cool before turning on the power again if you use this fast-discharge technique. Do not attempt to discharge the capacitors by shorting directly across them as this will damage them.

With the power-unit cover removed, orient the supply with the rectifier board on top, the line input board on the left and the inverter board on the right. This will make it convenient to get to all the test points as we go along.

LINE INPUT BOARD

First let's check the line input board. It's fairly easy to tell if this circuit is working. The neon bulb previously mentioned will start flashing when power is applied. On some units it assumes a steady glow, on others it continues to flash. The voltage reading on test points 810 and 811 should be approximately 300 volts DC depending upon the line voltage. Be careful not to ground any point in this circuit except test-point ground or chassis.

Typical troubles in this circuit causing the line fuse to open are shorted diodes on the bridge, CR810, or a shorted capacitor C810, C811, C813 or C814.

INVERTER BOARD

Next in line is the inverter circuit. The problems most common to this circuit are open fuse F810, shorted transistors Q825 or Q835, or shorted diodes CR825, CR835, CR828 or CR838. An open inverter fuse usually indicates trouble in the inverter.

Before working in this circuit, unplug the power cord and give the storage capacitors time to discharge. Remove the line selector cover containing the line and inverter fuses. We're now ready to make some resistance checks on the inverter board.

With your ohmmeter set to the $\times 1$ k Ω scale, take a reading between test points 826 and 836. The reading should be several megohms in one direction and ≈ 1.5 k Ω with the test leads reversed. Check between test points 836 and 820. You should get a high and low reading as before. This checks the transistors and important diodes in the inverter stage. If you get a low reading in both directions on either of these tests, remove the transistor from the side having the low reading in both directions. A set of readings between the appropriate test points will show whether it is the diode or the transistor that is defective. Diodes CR826 and CR836 are not checked by the above procedure but will not prevent the inverter from running even if shorted. Once you achieve a high resistance on both sides of the inverter, it will probably operate when you apply the proper power to it. However, before applying power, a quick check should be made on rectifier board test point 860 to ground. The resistance should be ≈ 2 k Ω or 40 k Ω depending on the polarity of the meter leads.

You can now prepare to apply power to the instrument. Install the line selector cover. Remove Q860 to disable the pre-regulator circuit. Connect your test scope between test point 836 and ground on the inverter board. Vertical sensitivity should be 50 V/div DC at the probe tip, the trace centered and the sweep speed set to 10 μ s/div. Connect a voltmeter between the +75 V test point and ground on the rectifier board. Plug the scope into an autotransformer and with the line voltage set at zero volts, turn the instrument on. Slowly advance the line voltage while watching the test scope. If the trace moves up or down, the inverter still has problems. If the trace holds steady, the inverter should start as the line voltage approaches 80 volts. A square wave of approximately 25 kHz and 200 volts will appear on the test scope. Do not advance the line voltage any further. The +75 volt supply should not be allowed to exceed 75 volts to prevent blowing the inverter fuse.

RECTIFIER BOARD

You are now ready to check the pre-regulator circuitry. Turn off the scope and return the line voltage to zero volts. Replace Q860 in its socket. Slowly advance the line voltage while monitoring the +75 volt supply. If the +75 volts holds steady, you can advance the line voltage to a normal setting. If the voltage is not stable or if the signal being monitored on test point 836 on the inverter board is erratic in frequency, the pre-regulator is not working properly. The quickest method of troubleshooting this circuit is to check the associated transistors with a curve tracer or ohmmeter. The waveforms shown on the facing page are typical for a properly operating supply.

MECHANICAL CONSIDERATIONS

Most of the components in the power supply are readily accessible from the top of the printed circuit boards. However, when it is necessary to remove a soldered-in component, we suggest you remove the circuit board from the assembly and unsolder the component from the back side of the board. The line input board and the rectifier board are readily

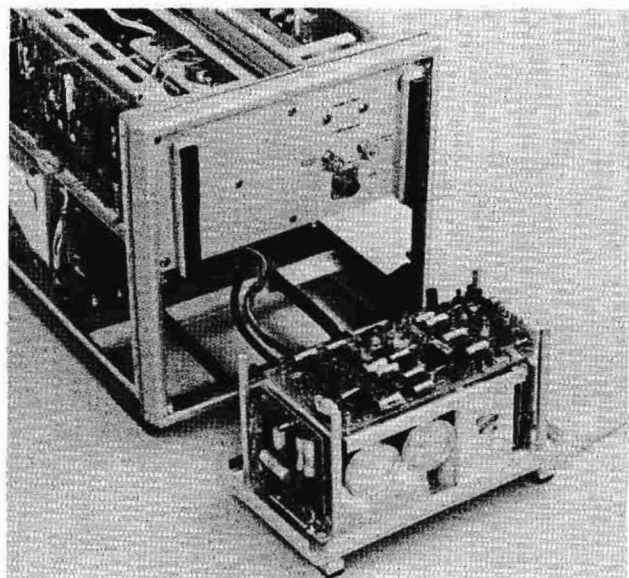

Low-voltage supply removed for easy servicing. Line input board is on the left side, rectifier board on top, and just the edge of the inverter board is visible at the right.

removed by loosening two or three screws. The inverter board is somewhat more difficult to remove; the manual gives the proper procedure.

Care should be exercised when replacing Q825 or Q835 located on the ceramic heat sink on the inverter board. The mounting studs are soldered into the printed circuit board and may be broken loose by applying excessive torque.

When placing the power unit back into the mainframe take care to properly dress the power unit cables between the power unit and the logic board. Lowering the swing-down gate on the right side of the instrument will let you guide the cables into place.

In the next issue of TEKSCOPE we will discuss the 7704 high voltage power supply.

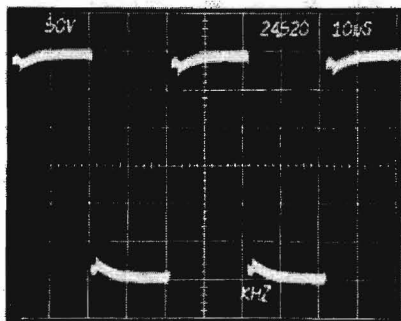

Typical waveform at TP836 for properly operating supply. Mid-screen is 0 Volts.

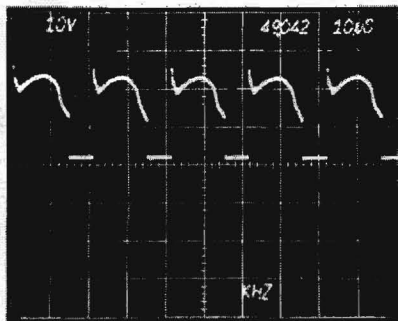

Waveform at TP860. Note frequency is twice that at TP836.

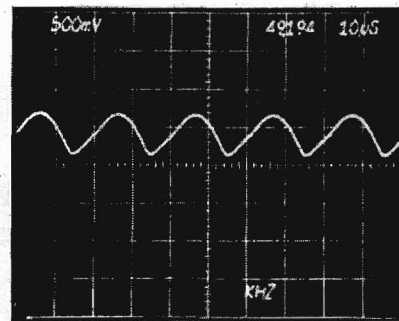

Waveform at TP859. Frequency increased slightly due to line voltage change.

INSTRUMENTS FOR SALE

561A, \$500. 3T77, \$500. 3S76, \$850. Harold Dove, 837 Uvalda St., Aurora, Colo. 80010. (303) 343-2906.

3-514D, 514AD, 524AD, 502, 541, 543A, 180A. 2 ea. 160A, 161, 163, 162. Jim Kennedy, Technitrol, Inc., 3825 Whitaker Ave., Phila., Pa. 19124. (215) 426-9105.

575, \$900. Hans Frank, Dynaco, Phila., Pa. (215) CE 2-8000.

502A, 202-1. Ron Calvanio or Dr. Denton, Mass. Gen'l Hospital, Dept. of Anesthesia, Fruit St., White Bldg., Boston, Mass. 02114. (617) 726-3851, 726-2034.

2 ea. 513D, 517. Dr. Frederic Davidson, E.E. Dept., Johns Hopkins Univ., Baltimore, Md. 21218. (301) 366-3300, Ext. 249.

515A. G. Katzen, 243 W. Main St., Cary, Ill. 60013. (312) 639-4768.

601, \$925. Dr. William Spickler, Cox Heart Institute, 3525 Southern Blvd., Kettering, Ohio 45429.

514D, \$250 or trade for 3 in. model. Arthur Pfalzer, Hoover Electric, Hangar 2, Port Columbus Airport, Columbus, Ohio 43219. (614) 235-9634.

561A, 3A6, 3B4. Package price, \$1250. Pierre Cathou, MIT Branch, P.O. Box 104, Cambridge, Mass. 02139. (617) 868-5782.

53G, \$100. 53/54B, \$85. Dan McKenna. (517) 725-7211.

2-453. Dave Ballstadt, Optical Digital Systems, 1175 E. Highway 36, St. Paul, Minn. 55109. (612) 484-8589.

513D. Lou Chall, 2834 Serange Place, Costa Mesa, Calif. 92626. (714) 545-6536.

549, 1A1, 202-2, \$2800 complete. J. C. Davis, Republic Nat'l Bank, Sunset Plaza, Pueblo, Colo. 81004.

611. Dr. Les Wanninger, General Mills, Inc., 9000 Plymouth Ave., N., Golden Valley, Minn. 55427. (612) 540-3444.

561A, 3A6, 3B3. Excellent condition. \$1000. Might accept 321 or 321A as part payment. (213) 792-4962.

323, \$850. C30AP, New, \$450. Harold Moss. (213) 398-1205.

536, 53/54K, 53/54T, \$800. \$54, \$300. Geo. Schneider, Profexray Div., Litton Medical Products, 1601 Beverly Blvd., Los Angeles, Calif. 90026. (213) 626-6861.

511AD, \$300. Carl Powell, 3906 Jackson Hwy. Sheffield, Ala. 35660. (205) 383-3330.

13-RM561A/2A60/2B67 never used. Attractive discount. J. Wieland, 16950 Encino Hills Dr., Encino, Calif. 91316.

316, \$600. I. R. Compton, Comptronics, 3220 - 16th West, Seattle, Wash. 98119. (206) 284-4842.

2B67, \$175. 63 Plug-In, \$100. Roger Kloepfer. (517) 487-6111, Ext. 392.

514A. Geo. Butcher, Electronics Marine, P.O. Box 1194, Newport Beach, Calif. 92663. (714) 673-1470.

1L20. George Bates, Dynair Elect., 6360 Federal Blvd., San Diego, Calif. 92114. (714) 582-9211.

611, \$2000. Dr. A. Sanderson, Harvard Univ., Electronics Design Center, 40 Oxford St., Cambridge, Mass. 02138. (617) 495-4472.

P6046 Probe, Amplifier, P.S., \$600. Bob Waters, Jr., ARCT, Inc., P.O. Box 11381, Greensboro, N.C. (919) 292-7450.

503 w/Grid. Wm. Gelb, Gelb Printing & Lithographing Co., 6609 Walton St., Detroit, Mich. 48210. (313) 361-4848.

555 complete. Scope Cart. Fred Samuel, Ch. Engr., WXTV, Ch. 41, 641 Main St., Paterson, N.J. 07503. (201) 345-0041.

547, 422, 453, 502, Plug-Ins, Cal. Fixtures. Manzano Laboratories, Inc., 146 Quincy Ave., N.E., Albuquerque, N.M. 87108. (505) 265-7511.

514AD, \$260. J. Barsoomian, 31 Porter St., Watertown, Mass. 02172. (617) 924-6475.

2-531A/CA, \$895. 2-531/CA, \$695. 53/54C, \$150. 2A63, \$125. J. Boyd, Tally Corp., 8301 180th South, Kent, Wash. 98031. (206) 251-5500, Ext. 6787.

545B, 1A1, 1A7. Scientific Industries, 150 Hericks Rd., Mineola, N.Y. (516) 746-5200.

547, 1A4, 1A2, 202-2, as package or individually. Phil DiVita, Data Display Systems, Inc., 139 Terwood Rd., Willow Grove, Pa. 19090. (215) 659-6900.

105, \$100. Charles Yelverton, Jones County Jr. College, Ellisville, Miss. 39437. (601) 764-3667.

516, \$1020. 564B/121N, \$876. 3A6, \$440, 3B3, \$544. 545B, \$1360. 1A1, \$520, 1A6, \$236. 201-1, \$116. 201-2, \$124. 202-2, \$124. Larry Glassman, 5584 Benton Woods Dr., N.E., Atlanta, Ga. 30342. (404) 255-5432.

531A, CA, 202 Mod. A. \$500 package. Tom Eckols, Dow Jones Co., Dallas, Texas. (214) ME 1-7250.

INSTRUMENTS WANTED

453, W. Pfeiffer, 1332 E. Portland, Springfield, Mo. 65804. (417) 869-0249.

519. John Barth, Barth Corp., 7777 Wall St., Cleveland, Ohio 44125. (216) 524-5136.

503, A. Ruben, Medical Sales & Service, 270 E. Hamilton St., Allentown, Pa. 18103. (215) 437-2526.

R561A or B, with or without Plug-Ins. Dr. Paul Coleman, Univ. of Rochester Medical Cntr., Anatomy Dept., Rochester, N.Y. 14620. (716) 275-2581.



TEKSCOPE

Volume 3

Number 2

March 1971

Customer Information from Tektronix, Inc., P.O. Box 500, Beaverton, Oregon 97005
Editor: Gordon Allison Artist: Nancy Sageser For regular receipt of TEKSCOPE contact your local field engineer.

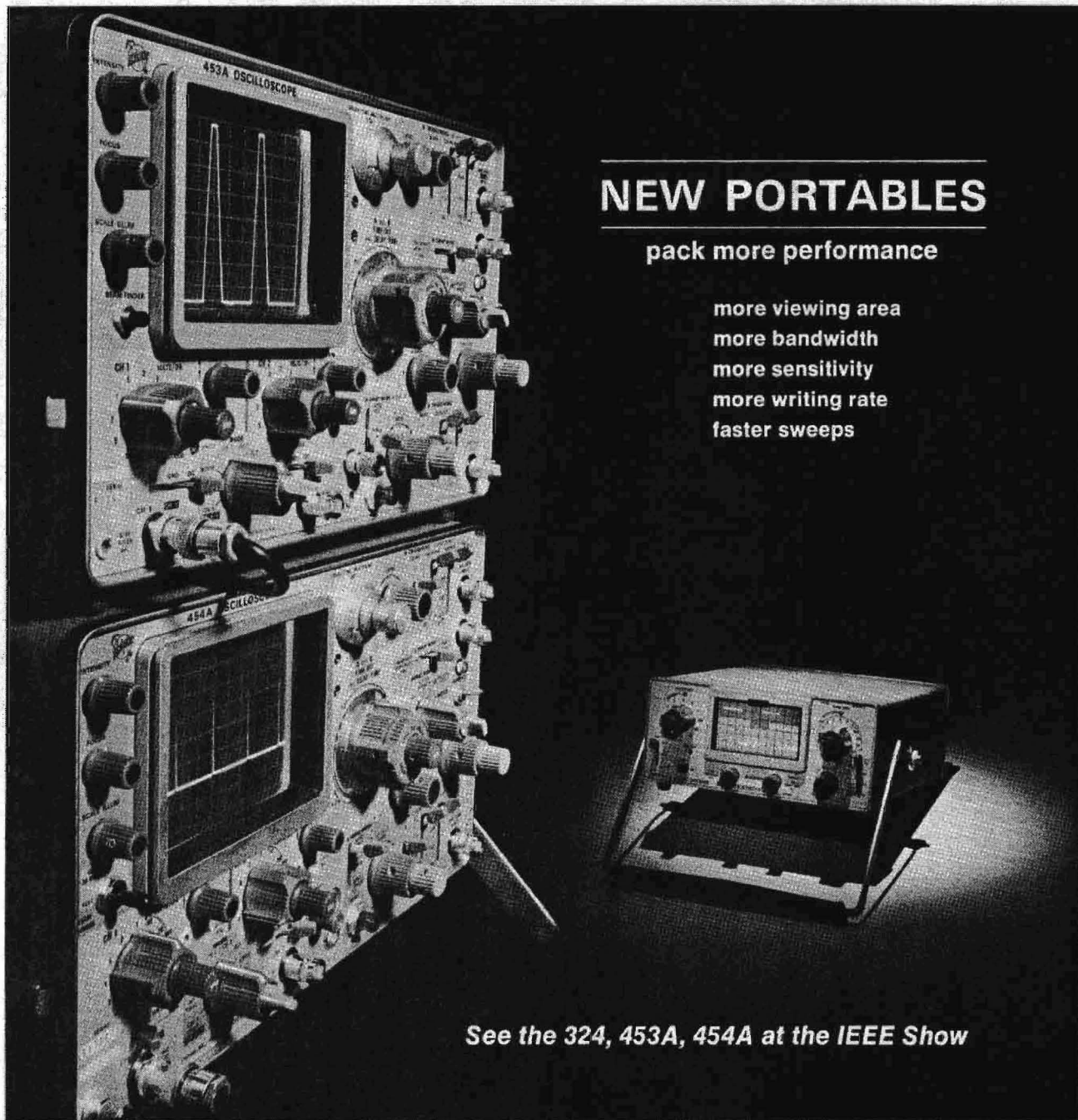

NEW PORTABLES

pack more performance

more viewing area
more bandwidth
more sensitivity
more writing rate
faster sweeps

See the 324, 453A, 454A at the IEEE Show

TEKTRONIX, INC.
P.O. BOX 500
BEAVERTON, OR. 97005